



NATIONAL MEASURES®

Billing : PO Box 1149

Physical : 7920 West 215th Street

Lakeville, Minnesota 55044

Phone # (952)469-4977

Toll Free 1-800-328-4577

Email: orders@airliteplastics.com

Scoop Specification

For 4 cc Scoop

This material is FDA compliant and is free of heavy metals, CFCs and BPA. This product does NOT contain chemical substances proposed to be Very High Concern above .1% threshold. This product complies with EU food contact legislation including EU No10/2011 as amended, when used in food packaging applications.

NOTE: Measurements shown on specification drawings are correct as shown below, +/-5% tolerance on all measurements. Images on this page are not to scale.

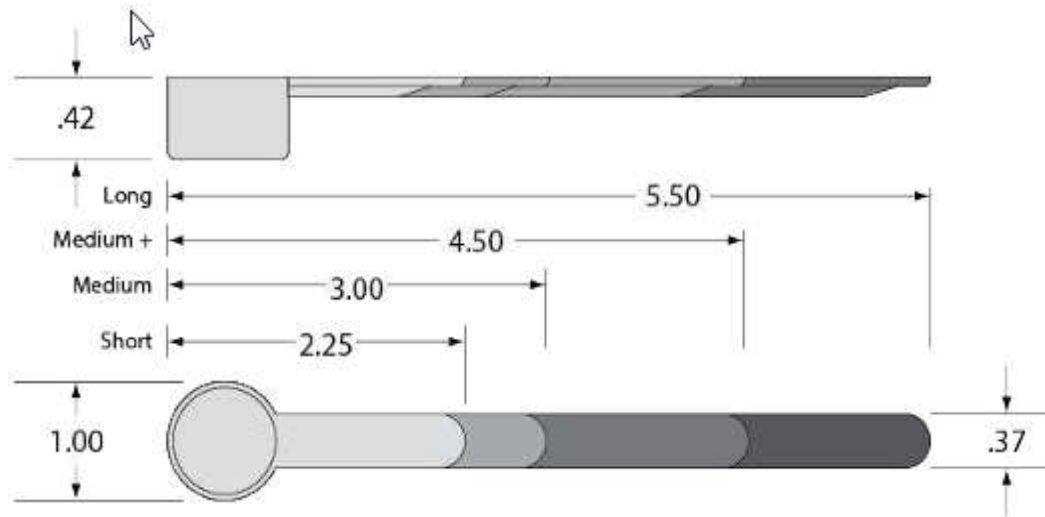

www.nationalmeasures.com