

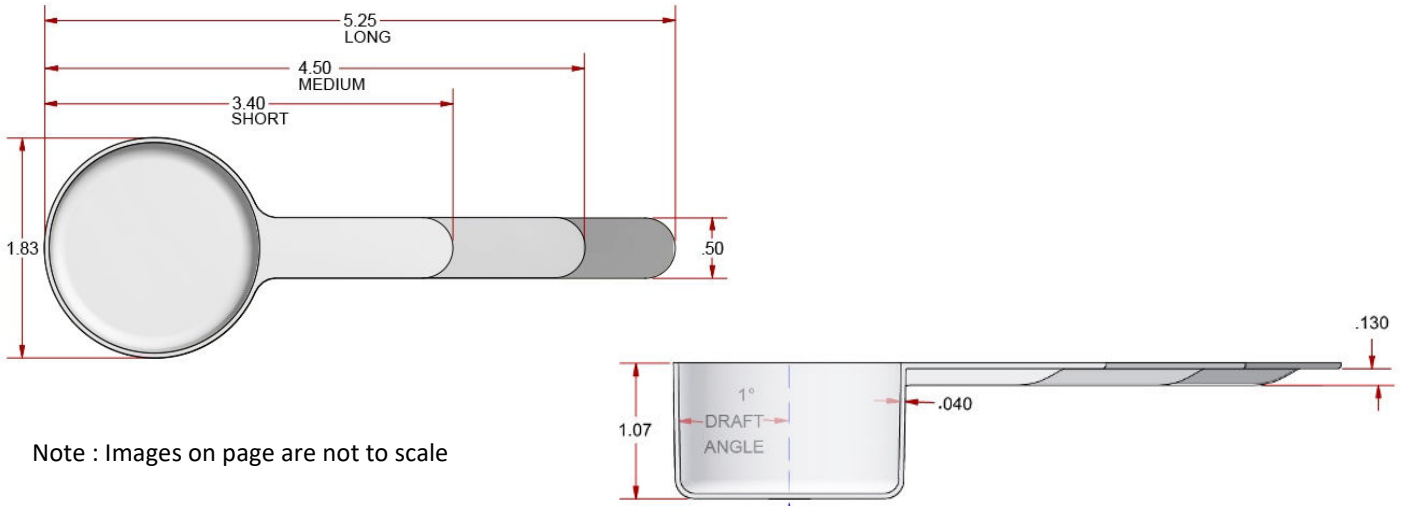

39.0 cc SCOOP SPECIFICATION

This polypropylene material is FDA compliant and is free of heavy metals, CFC's and BPA. This product does not contain chemical substances proposed to be very high concern above .1% threshold. This product complies with EU food contact legislation including EU No10/2011 as amended, when used in food packaging applications.



Note : Images on page are not to scale

3 overall Lengths	3.4"	4.5"	5.25"
PRODUCT ID	39.0D3.4	39.0D4.5	39.0D5.25
CARTON QUANTITY	800 pcs.	700 pcs	600 pcs.
CARTON WEIGHT	12#	11#	11#
All CARTON DIMENSIONS	20" x 16" x 15"		
CARTONS/PALLET	30 ctns. Skid dims. - 48" x 41" x 82.5"		

PLANT LOCATIONS—

Measurex
 2860 Bath Pike
 Nazareth, PA. 18064
 (610) 759-0280

National Measures
 7920 West 215th St.
 Lakeville, MN. 55044
 (952) 469-4977

www.measurexscoops.com

www.nationalmeasures.com