



NATIONAL MEASURES®

Billing : PO Box 1149

Physical : 7920 West 215th Street

Lakeville, Minnesota 55044

Phone # (952)469-4977

Toll Free 1-800-328-4577

Email: orders@airliteplastics.com

Scoop Specification

For 16 cc Scoop

This material is FDA compliant and is free of heavy metals, CFCs and BPA. This product does NOT contain chemical substances proposed to be Very High Concern above .1% threshold. This product complies with EU food contact legislation including EU No10/2011 as amended, when used in food packaging applications.

NOTE: Measurements shown on specification drawings are correct as shown below, +/-5% tolerance on all measurements. Images on this page are not to scale.

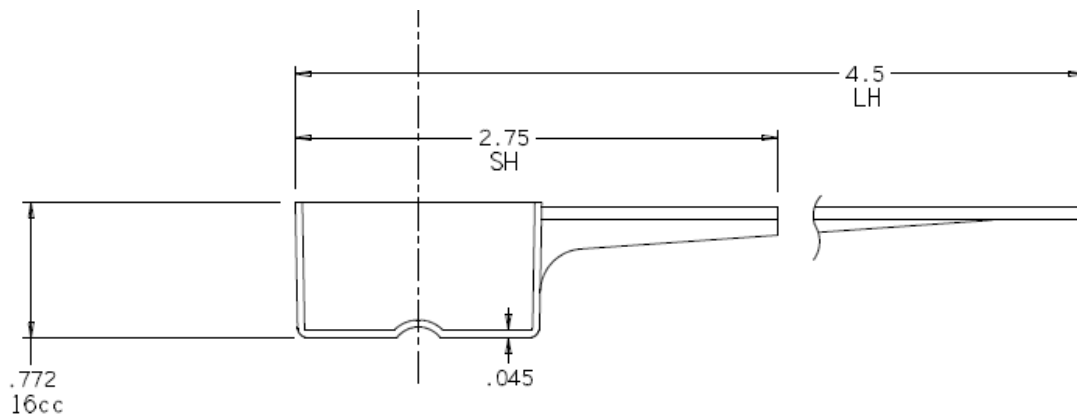

www.nationalmeasures.com